

HELUTEK® M17
Montageanleitungen
HELUTEK® M17
Mounting instructions

Montageanleitungen

Mounting instructions

STECKER LEISTUNG

Polzahl: 7-polig
Kontaktart: Crimpkontakte

PLUG - POWER

No. of contacts: 7
Connection: Crimping contacts

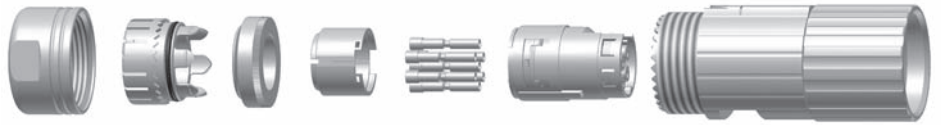

M17 SERIE

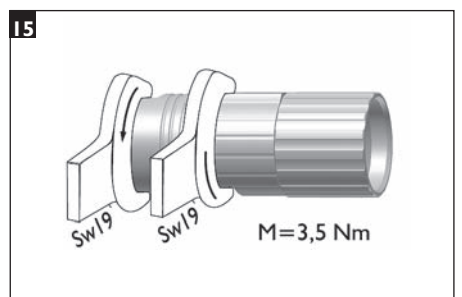
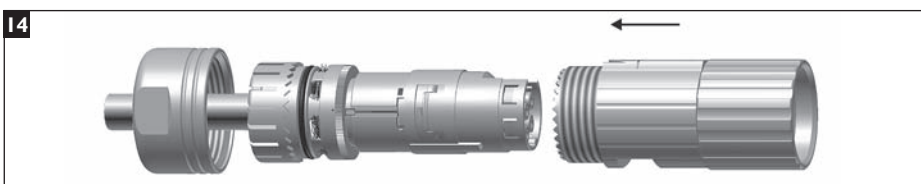
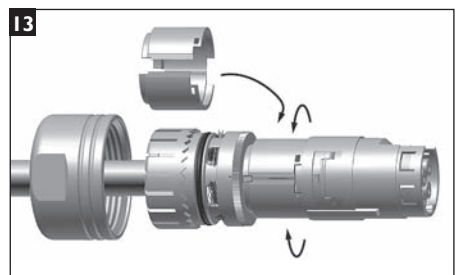
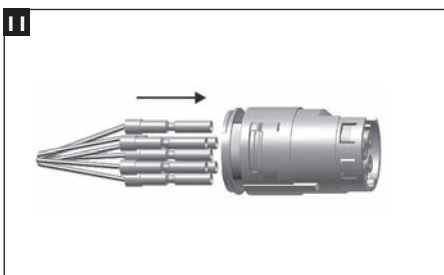
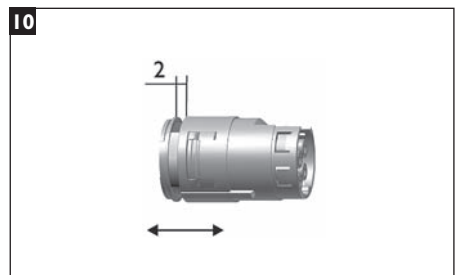
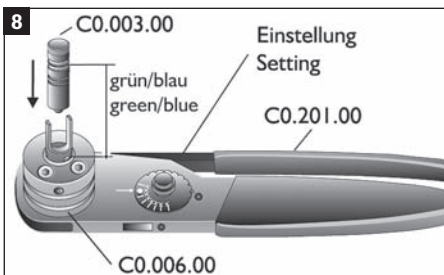
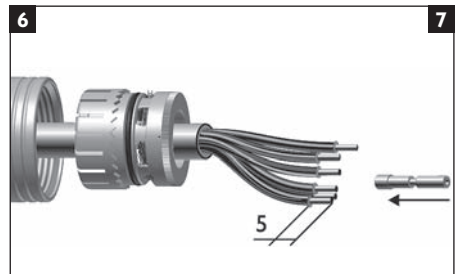
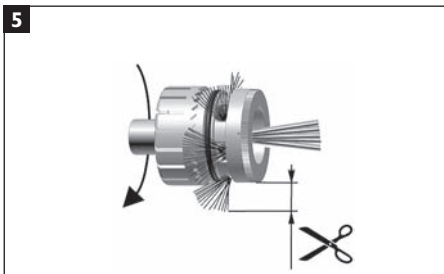
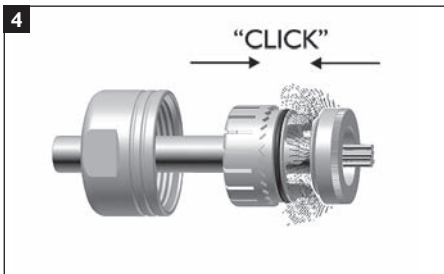
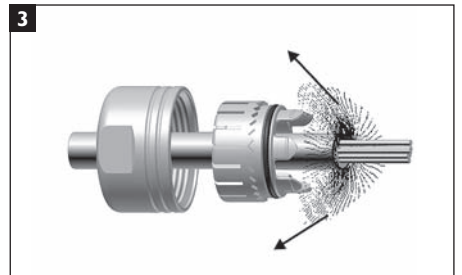
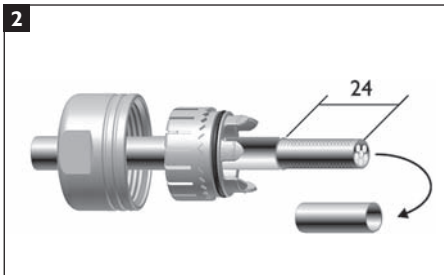
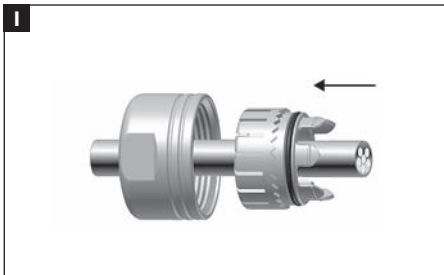

Kombination Crimpzange/ Positioniereinsatz | Combination crimping pliers/ positioning insert

	a (mm ²)	Crimpzange crimp pliers	Pos. -Einsatz Pos. insert	Farbring Color ring
Leistung Power	0.14 - 1.0	CO.201.00	CO.003.00	grün green
Leistung Power	0.5 - 1.5	CO.201.00	CO.121.60	blau blue

Helutec® Montageanleitungen dienen nur zur allgemeinen Anwender-Information. Änderungen jeder Art und Irrtum vorbehalten. Stand 04/2005.

Als verbindlich gelten ausschließlich die Montage- und Verarbeitungsanleitungen, die projektbezogen zusammen mit den Steckverbindern oder Steckverbinderkomponenten zur Verfügung gestellt werden.

Helutec® mounting instructions published here are for general information purposes only. All data are subject to change without notice, errors excepted.

Helutec® mounting instructions are mandatory, only when supplied together with connectors, components or project related documents. PDF file generated 04/2005.

KUPPLUNG LEISTUNG

Polzahl: 7-polig
Kontaktart: Crimpkontakte

EXTENSION - POWER

No. of contacts: 7
Connection: Crimping contacts

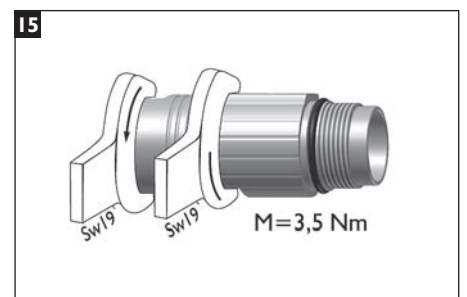
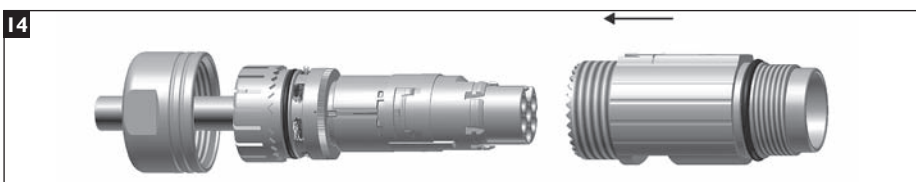
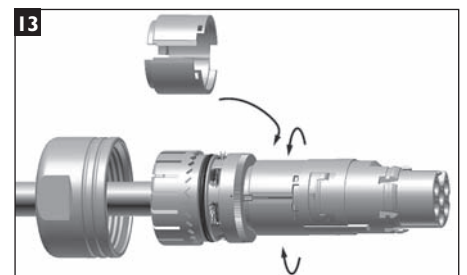
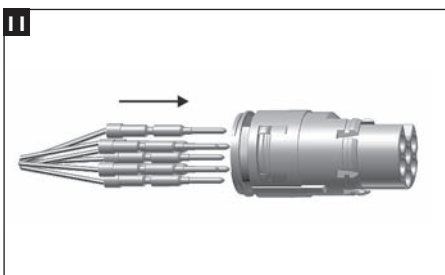
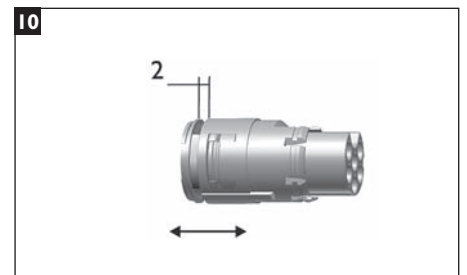
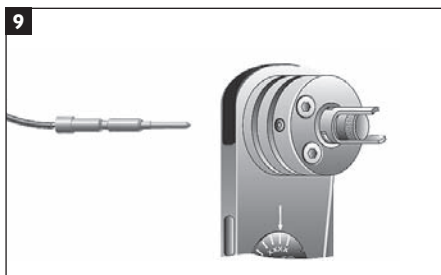
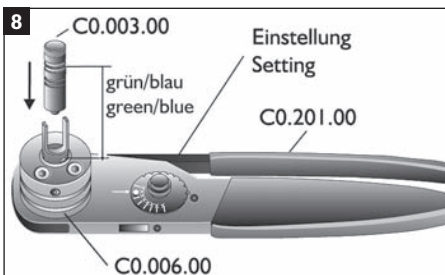
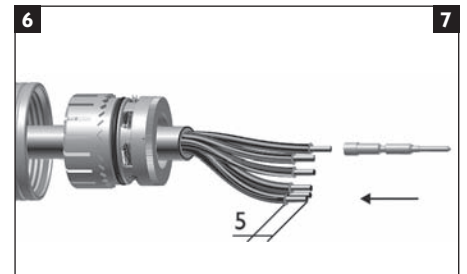
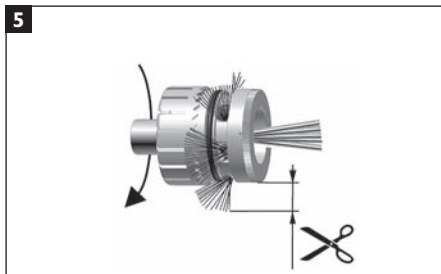
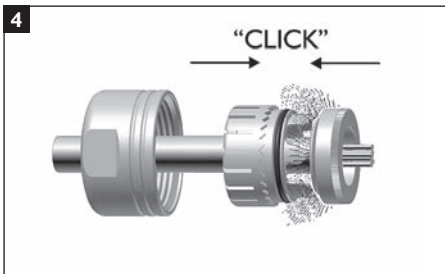
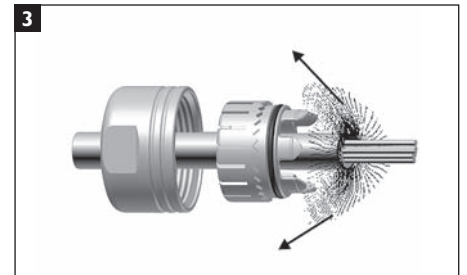
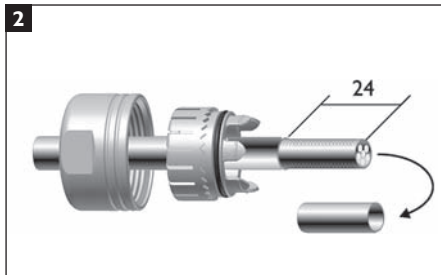
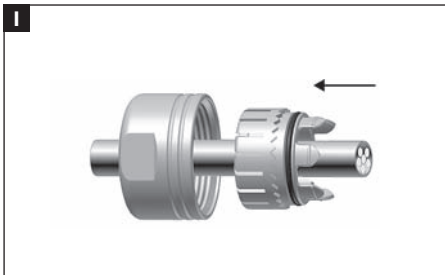
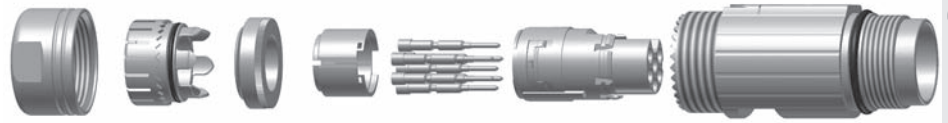

Kombination Crimpzange/ Positioniereinsatz | Combination crimping pliers/ positioning insert

	a (mm ²)	Crimpzange crimp pliers	Pos.-Einsatz Pos. insert	Farbring Color ring
Leistung Power	0.14 - 1.0	C0.201.00	C0.003.00	grün green
Leistung Power	0.5 - 1.5	C0.201.00	C0.121.60	blau blue

Helutec® Montageanleitungen dienen nur zur allgemeinen Anwender-Information. Änderungen jeder Art und Irrtum vorbehalten. Stand 04/2005.

Als verbindlich gelten ausschließlich die Montage- und Verarbeitungsanleitungen, die projektbezogen zusammen mit den Steckverbindern oder Steckverbinderkomponenten zur Verfügung gestellt werden.

Helutec® mounting instructions published here are for general information purposes only. All data are subject to change without notice, errors excepted.

Helutec® mounting instructions are mandatory, only when supplied together with connectors, components or project related documents. PDF file generated 04/2005.

Montageanleitungen

Mounting instructions

EINBAUDOSE GERADE LEISTUNG

Polzahl: 7-polig
Kontaktart: Crimpkontakte

RECEPTACLE STRAIGHT POWER

No. of contacts: 7
Connection: Crimping contacts



M17 SERIE

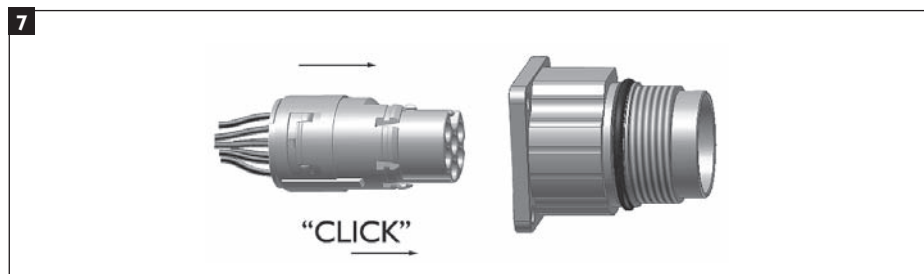
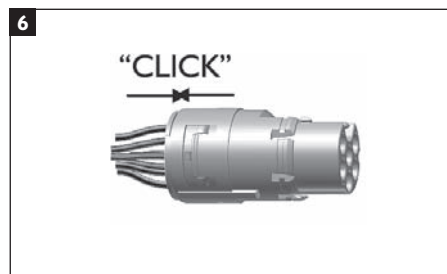
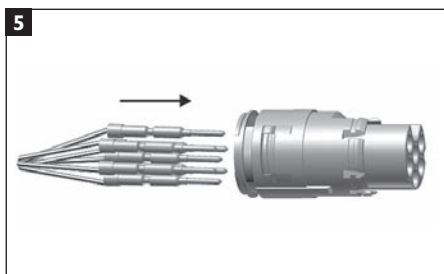
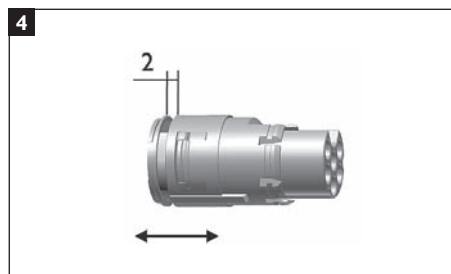
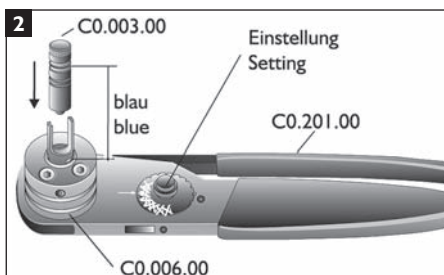
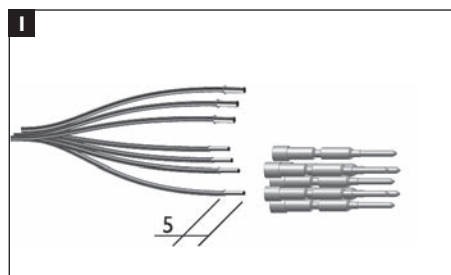

Kombination Crimpzange/ Positioniereinsatz		Combination crimping pliers/ positioning insert			
	a (mm ²)	Crimpzange crimp pliers	Pos.-Einsatz Pos. insert	Farbring Color ring	
Leistung Power	0.14 - 1.0	C0.201.00	C0.003.00	blau blue	
Leistung Power	0.5 - 1.5	C0.201.00	C0.121.60	blau blue	

Demontage | Demounting

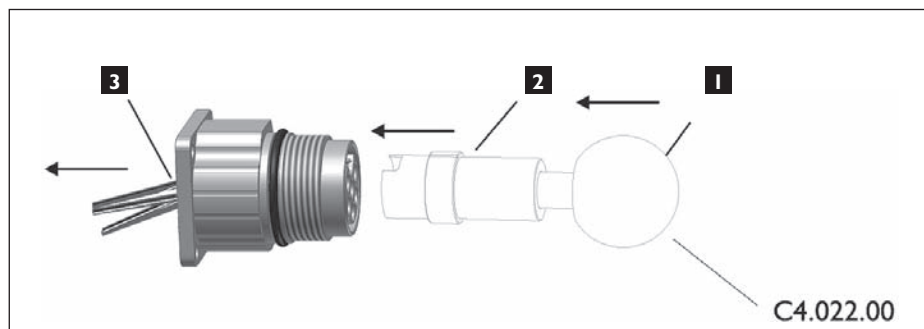

Helutec® Montageanleitungen dienen nur zur allgemeinen Anwender-Information. Änderungen jeder Art und Irrtum vorbehalten. Stand 04/2005.

Als verbindlich gelten ausschließlich die Montage- und Verarbeitungsanleitungen, die projektbezogen zusammen mit den Steckverbindern oder Steckverbinderkomponenten zur Verfügung gestellt werden.

Helutec® mounting instructions published here are for general information purposes only. All data are subject to change without notice, errors excepted.

Helutec® mounting instructions are mandatory, only when supplied together with connectors, components or project related documents. PDF file generated 04/2005.

**EINBAUDOSE ABGEWINKELT
LEISTUNG**

Polzahl: 7-polig
Kontaktart: Crimpkontakte

**RECEPTACLE ANGLED
POWER TYPE**

No. of contacts: 7
Connection: Crimping contacts

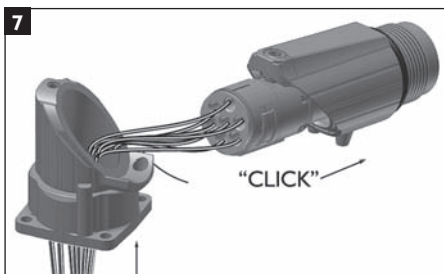
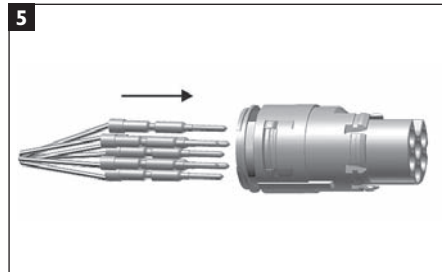
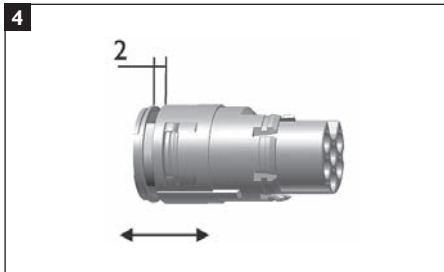
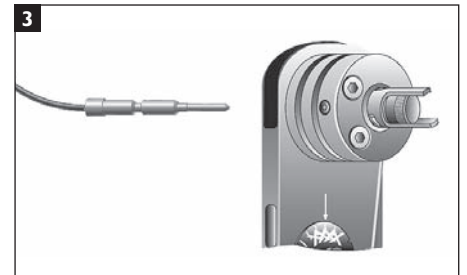
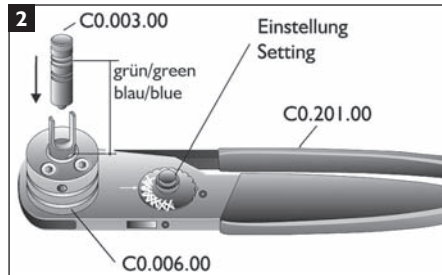
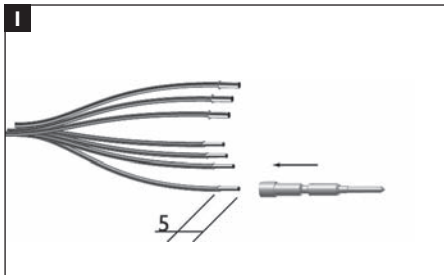

Kombination Crimpzange/ Positioniereinsatz Combination crimping pliers/ positioning insert						
	a (mm ²)	Crimpzange crimp pliers	Pos. -Einsatz Pos. insert	Farbring Color ring		
Leistung Power	0.14 - 1.0	C0.201.00	C0.003.00	grün green		
Leistung Power	0.5 - 1.5	C0.201.00	C0.121.60	blau blue		

Demontage | Demounting

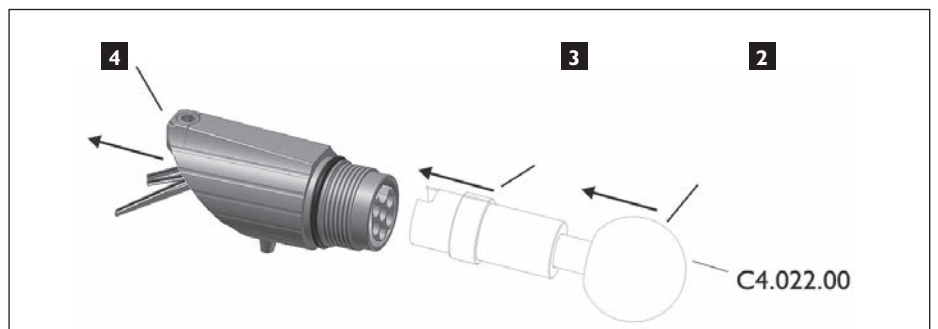
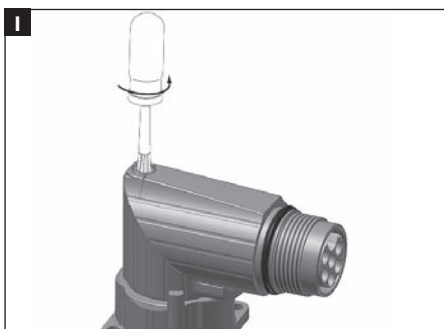

Helutec® Montageanleitungen dienen nur zur allgemeinen Anwender-Information. Änderungen jeder Art und Irrtum vorbehalten. Stand 04/2005.

Als verbindlich gelten ausschließlich die Montage- und Verarbeitungsanleitungen, die projektbezogen zusammen mit den Steckverbindern oder Steckverbinderkomponenten zur Verfügung gestellt werden.

Helutec® mounting instructions published here are for general information purposes only. All data are subject to change without notice, errors excepted.

Helutec® mounting instructions are mandatory, only when supplied together with connectors, components or project related documents. PDF file generated 04/2005.

Montageanleitungen

Mounting instructions

STECKER LEISTUNG

Polzahl: 9-polig
 Kontaktart: Crimpkontakte

PLUG - POWER

No. of contacts: 9
 Connection: Crimping contacts



M17 SERIE

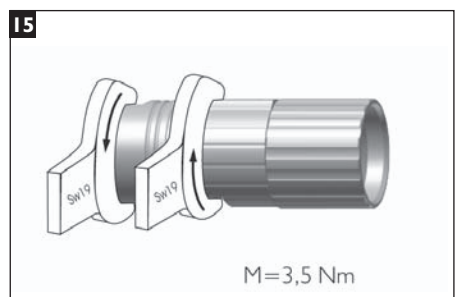
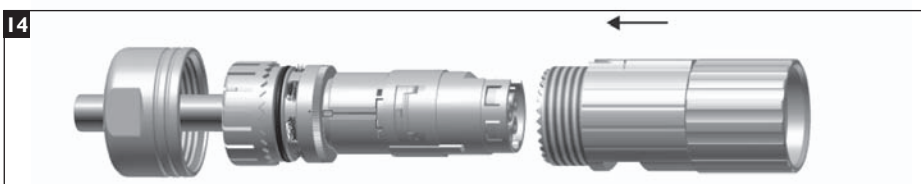
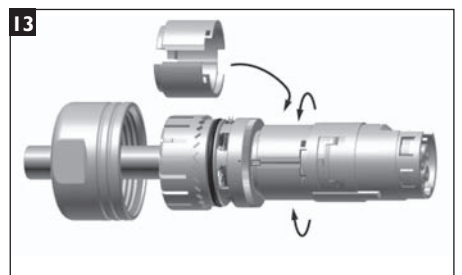
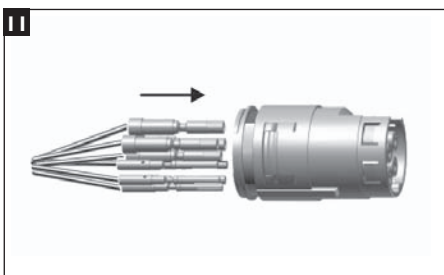
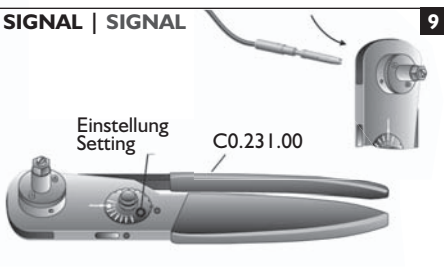
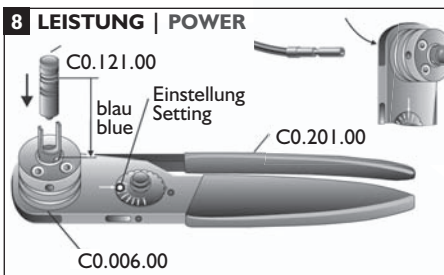
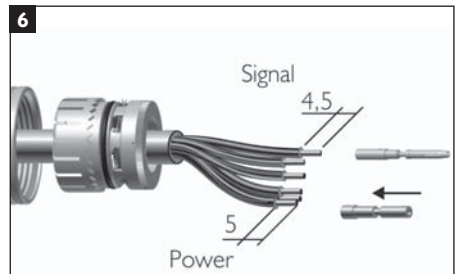
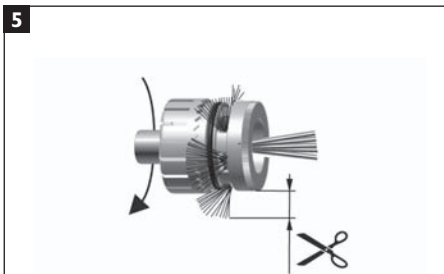
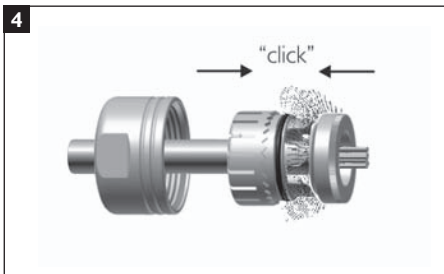
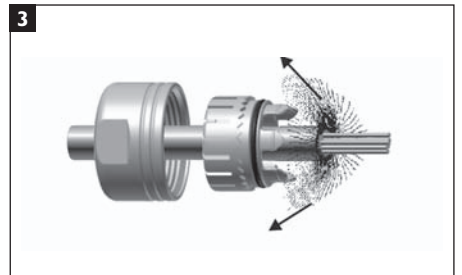
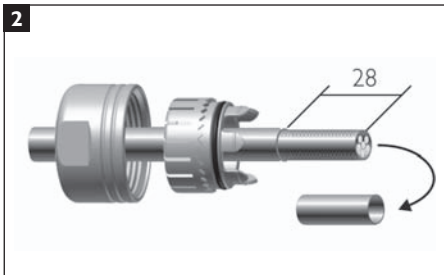
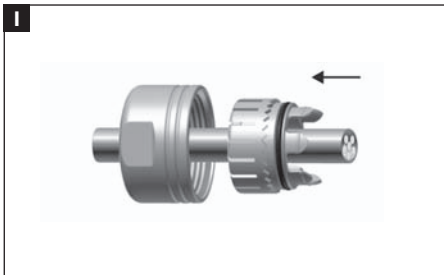

Kombination Crimpzange/ Positioniereinsatz		Combination crimping pliers/ positioning insert		
Leistung Power	a (mm ²)	Crimpzange crimp pliers	Pos. -Einsatz Pos. insert	Farbring Color ring
	0.5 - 1.5	C0.201.00	C0.121.00	blau blue

Helutec® Montageanleitungen dienen nur zur allgemeinen Anwender-Information. Änderungen jeder Art und Irrtum vorbehalten. Stand 04/2005.

Als verbindlich gelten ausschließlich die Montage- und Verarbeitungsanleitungen, die projektbezogen zusammen mit den Steckverbindern oder Steckverbinderkomponenten zur Verfügung gestellt werden.

Helutec® mounting instructions published here are for general information purposes only. All data are subject to change without notice, errors excepted.

Helutec® mounting instructions are mandatory, only when supplied together with connectors, components or project related documents. PDF file generated 04/2005.

KUPPLUNG LEISTUNG

Polzahl: 9-polig
Kontaktart: Crimpkontakte

EXTENSION - POWER

No. of contacts: 9
Connection: Crimping contacts

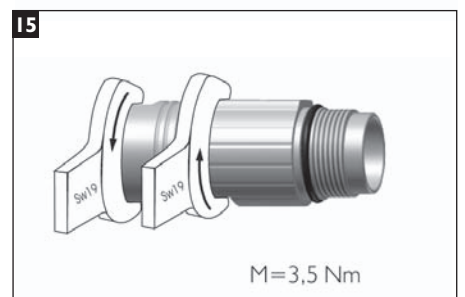
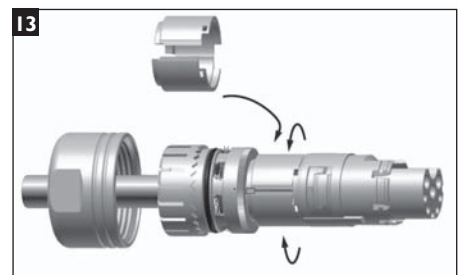
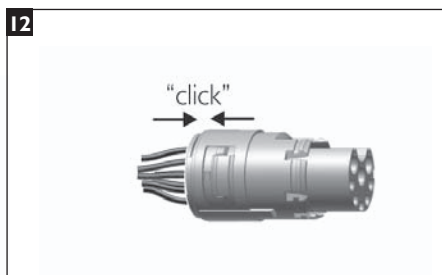
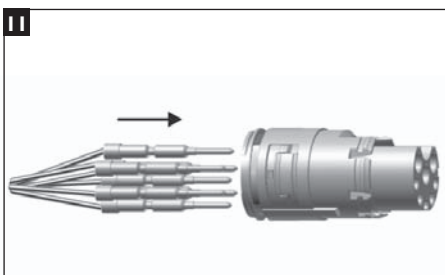
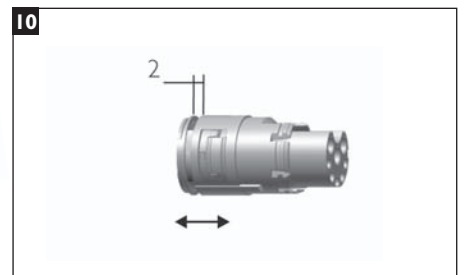
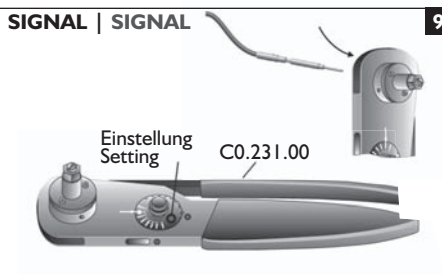
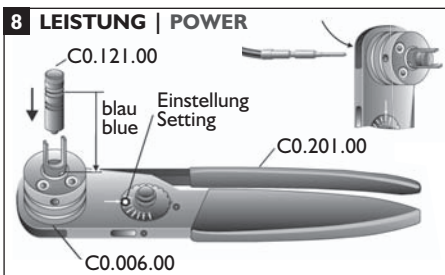
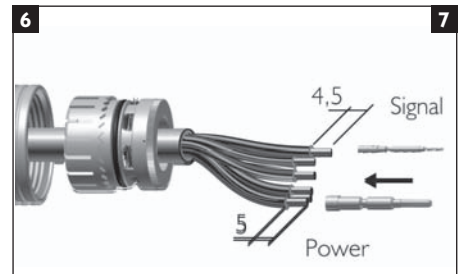
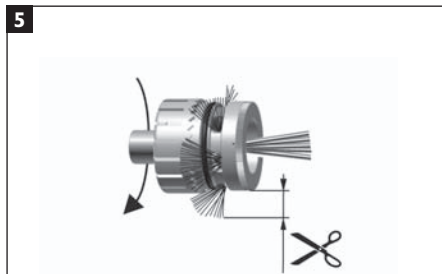
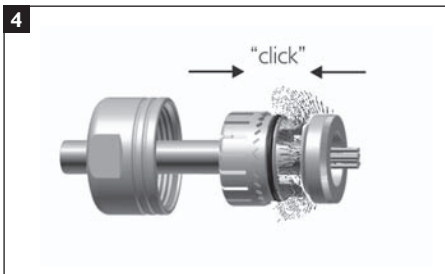
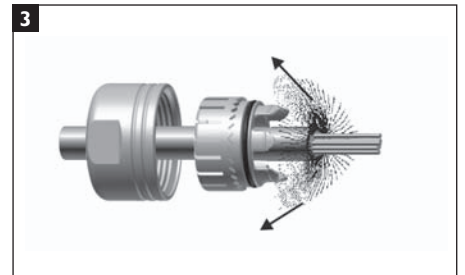
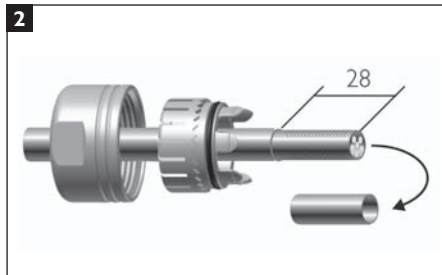
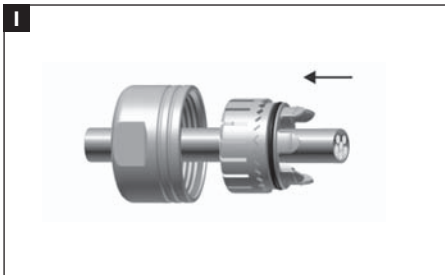
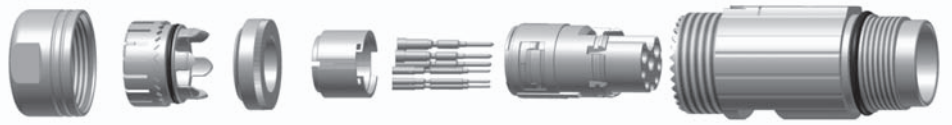

Kombination Crimpzange/ Positioniereinsatz Combination crimping pliers/ positioning insert				
	a (mm ²)	Crimpzange crimp pliers	Pos.-Einsatz Pos. insert	Farbring Color ring
Leistung Power	0.5 - 1.5	C0.201.00	C0.121.00	blau blue

Helutec® Montageanleitungen dienen nur zur allgemeinen Anwender-Information. Änderungen jeder Art und Irrtum vorbehalten. Stand 04/2005.

Als verbindlich gelten ausschließlich die Montage- und Verarbeitungsanleitungen, die projektbezogen zusammen mit den Steckverbindern oder Steckverbinderkomponenten zur Verfügung gestellt werden.

Helutec® mounting instructions published here are for general information purposes only. All data are subject to change without notice, errors excepted.

Helutec® mounting instructions are mandatory, only when supplied together with connectors, components or project related documents. PDF file generated 04/2005.

Montageanleitungen

Mounting instructions

EINBAUDOSE LEISTUNG ABGEWINKELT, DREHBAR

Polzahl: 9-polig
Kontaktart: Crimpkontakte

RECEPTACLE POWER ANGLED, ROTATABLE

No. of contacts: 9
Connection: Crimping contacts



M17 SERIE

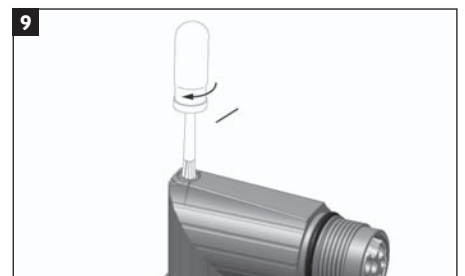
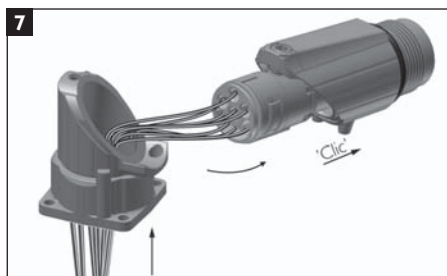
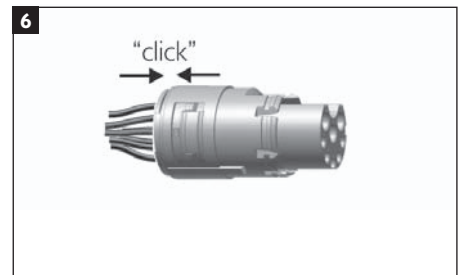
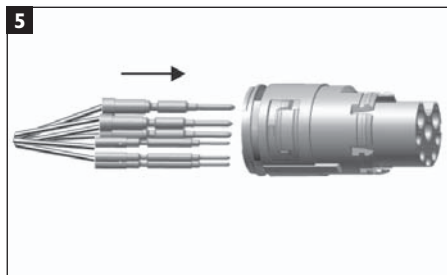
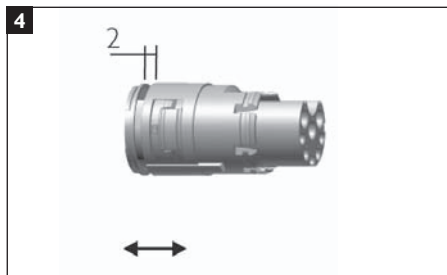
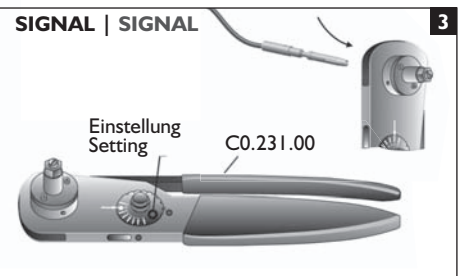
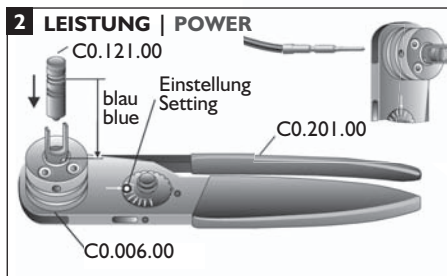
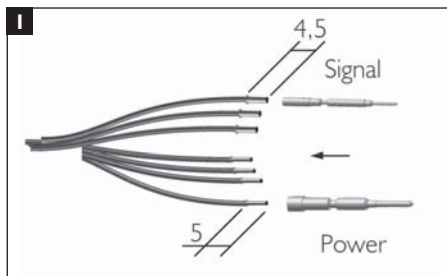

Kombination Crimpzange/ Positioniereinsatz		Combination crimping pliers/ positioning insert			
Leistung Power	a (mm ²)	Crimpzange crimp pliers	Pos.-Einsatz Pos. insert	Farbring Color ring	
	0.5 - 1.5	C0.201.00	C0.121.00	blau blue	

Demontage | Demounting

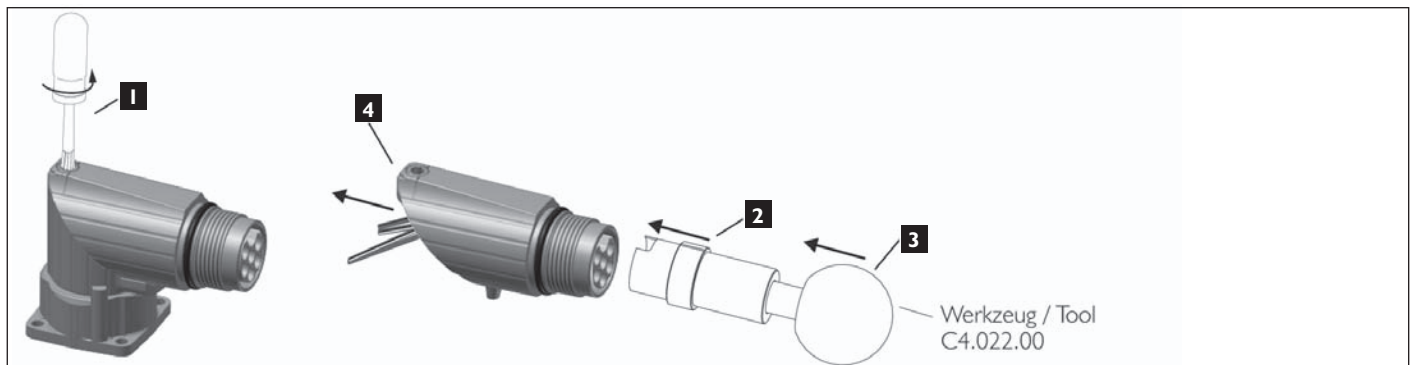

Helutec® Montageanleitungen dienen nur zur allgemeinen Anwender-Information. Änderungen jeder Art und Irrtum vorbehalten. Stand 04/2005.

Als verbindlich gelten ausschließlich die Montage- und Verarbeitungsanleitungen, die projektbezogen zusammen mit den Steckverbindern oder Steckverbinderkomponenten zur Verfügung gestellt werden.

Helutec® mounting instructions published here are for general information purposes only. All data are subject to change without notice, errors excepted.

Helutec® mounting instructions are mandatory, only when supplied together with connectors, components or project related documents. PDF file generated 04/2005.

Any questions about HELUTEC® connectors?
Don't hesitate to contact us.

HELUKABEL GmbH

Headquarters

Dieselstraße 8-12
D-71282 Hemmingen
Germany

Phone +49 (0) 71 50 / 92 09-0

Fax +49 (0) 71 50 / 8 17 86

Email: info@helukabel.de

International branch offices:

France • Switzerland • Netherlands • Sweden

Czech Republic • Poland • Slovakia • Turkey

China • India • Singapore • South Korea • Thailand